



Polarizing plate, Wave plate, Circularly polarizing plate

**general catalog**

Polarizing plate

**POLAX**

**Series**

Wave plate

**RETAX**

**Series**

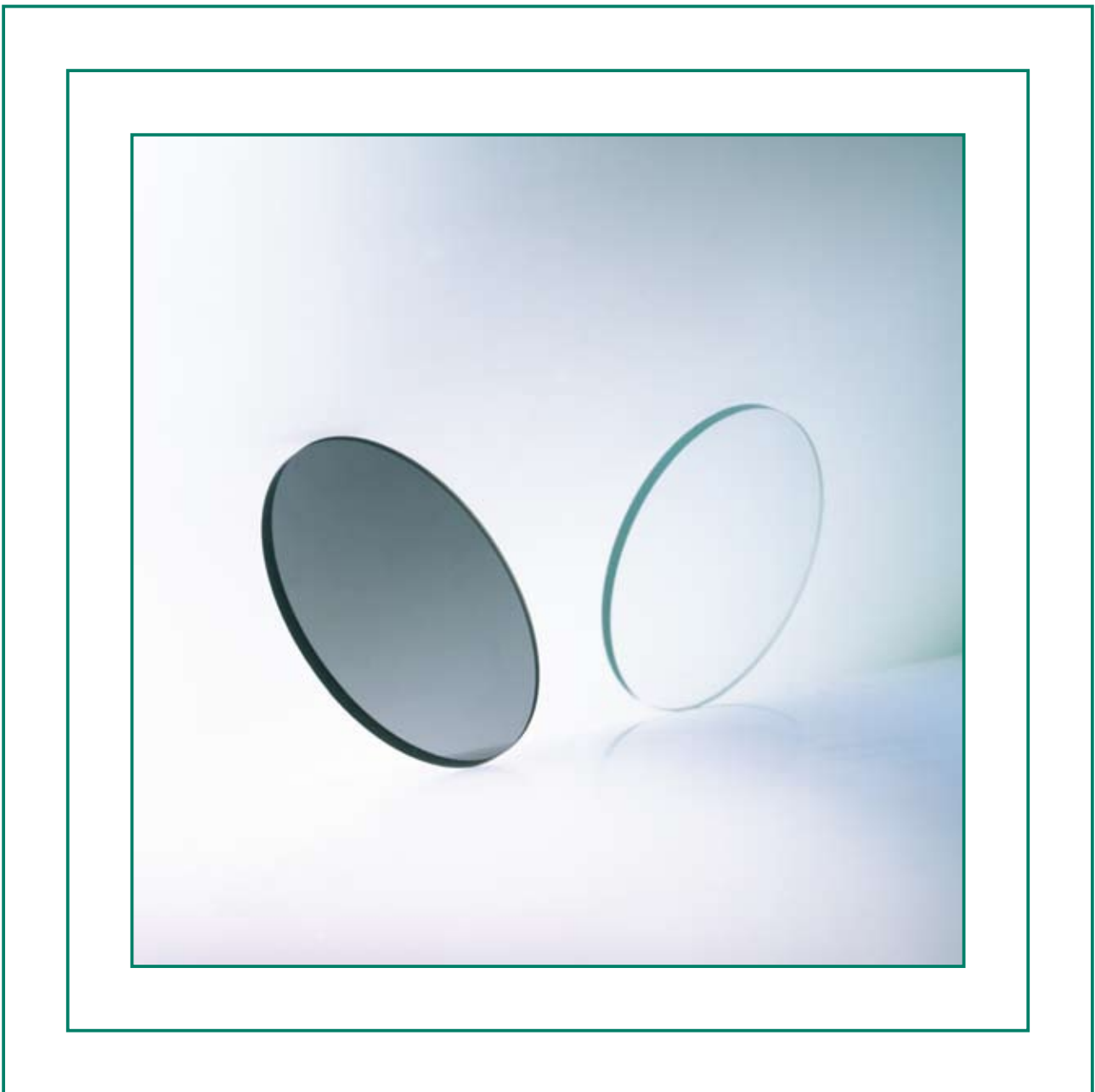

**Optical filters consist of high performance film sandwiched by glass plates.**

# About light

## ? Light is ...

**Light is a kind of electromagnetic waves. It has a character of wave.**

Electromagnetic waves are waves traveling in space while the electric and magnetic fields influence each other. Electromagnetic waves are classified according to wavelength as follows.

Light that can be recognized by human eyes is called visible light.

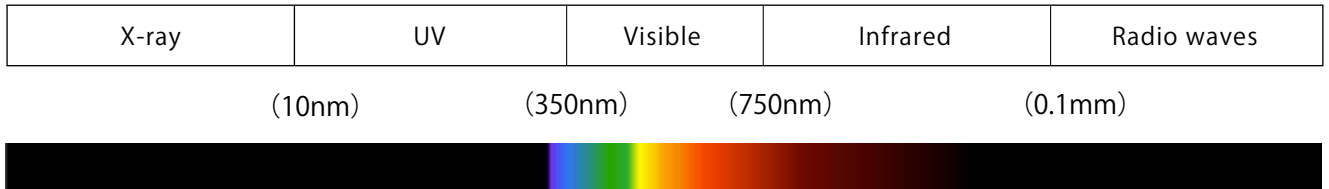

## ? What is wavelength?

**It is the distance when the light wave vibrates once.**

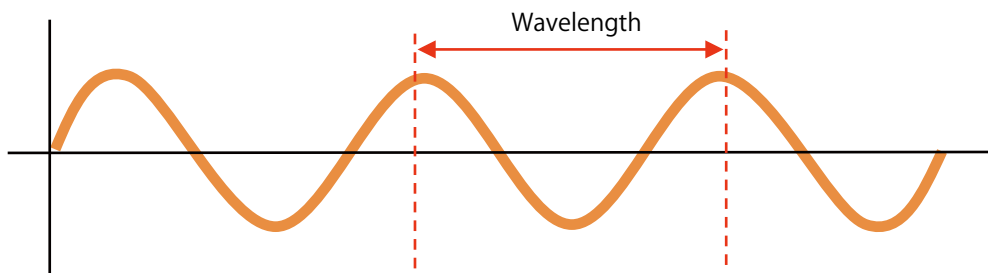

## ? What is polarized light?

**It is a biased light of which the vibration direction vibrates only in a regular direction.**

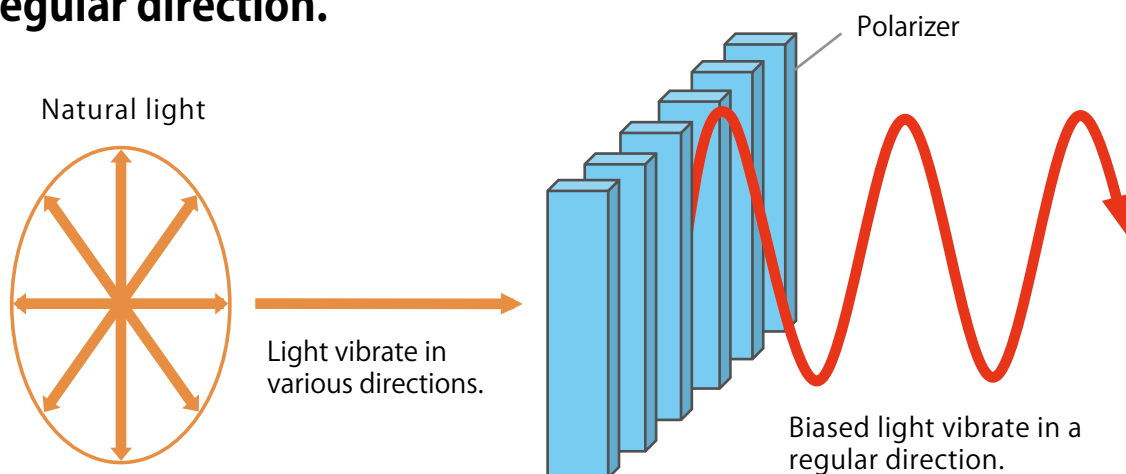

**By controlling the light, new technology will be born.**

Optical technology is used in various fields such as manufacturing, medical, information, communication.

Luceo offers products related to optics necessary for optical technology.

## Luceo Optical Filters

**Luceo's advantages are manufacturing technologies of optical films and gluing technologies that we have cultivated since the foundation over 50 years ago.**

Luceo manufactures optical filters of polarizers and wave plates with utilizing these technologies.

According to customer's requests, we are able to make optical filters with our technologies.

Besides standard products, Luceo can provide custom-made filters a minimum order quantity of 1 piece because we manufacture films in-house.



## Application of polarizers and wave plates

Luceo optical filters are utilized not only for components of optical equipment but also in laboratories of universities and companies, and have contributed to development of optical technology in a wide field.

Microscope

Polariscope

Inter-ferometer

Exposure  
Equipment

Inspection  
Device

Optical Pickup

Verifying direction  
of polarized light

Tuning Light  
Volume

Optical Isolator

# Polarizer

## POLAX Series

POLAX is a polarizer of iodine system.

A dichroic polarizing film is glued within excellent optical glass plates.

Lineup has various types from visible light range to near infrared light range .

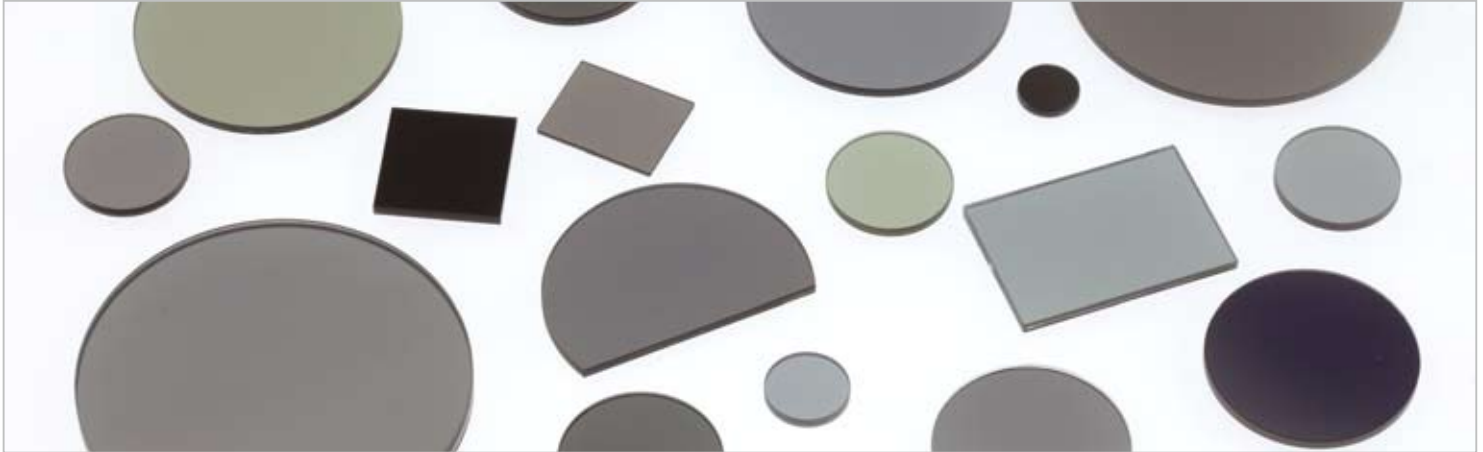

Polarizer is one of optical element to get out linearly polarized light from randomly polarized light such as natural light.

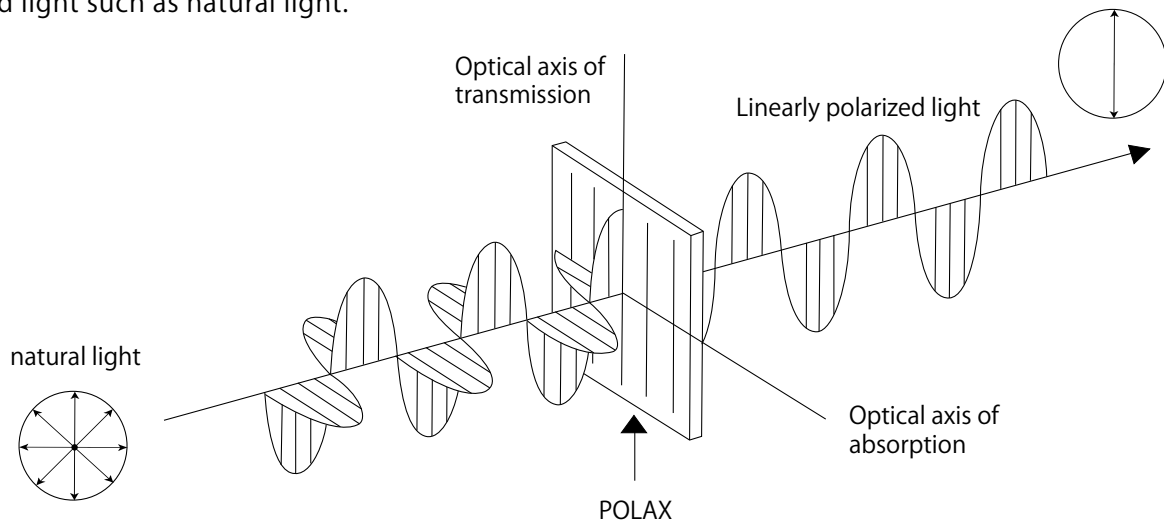

## POLAX Configuration diagram of standard products

Glass material	BK7	
Size (Diameter)	Φ10 (0/-0.2) mm	
	Φ20 (0/-0.2) mm	
	Φ30 (0/-0.2) mm	
Thickness	2 (±0.2) mm	
AR Coating	N, S, NIR	Multi layer coating on both faces
	IR	None

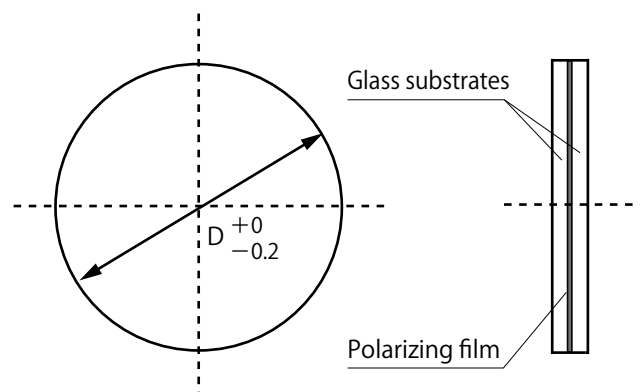

# POLAX Lineup

## POLAX-15N

Visible light range

POLAX-15N is the highest extinction ratio polarizer in POLAX series and it is developed for a leak prevention of blue light in visible light.



Optical character	Average Transmittance (400~680nm)	Extinction ratio (460nm)	Extinction ratio (530nm)	Extinction ratio (630nm)
POLAX-15N	15%±2%	10 <sup>5</sup>	10 <sup>5</sup>	10 <sup>5</sup>

## POLAX-25N

Visible light range

POLAX-25N is a high performance polarizer in visible light range.

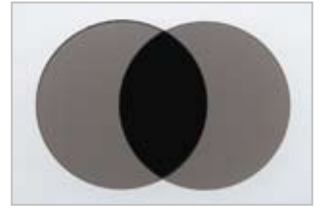

Optical character	Average Transmittance (400~680nm)	Extinction ratio (460nm)	Extinction ratio (530nm)	Extinction ratio (630nm)
POLAX-25N	25%±2%	10 <sup>3</sup>	10 <sup>4</sup>	10 <sup>4</sup>

## POLAX-32N

Visible light range

POLAX-32N is the average polarizing performance which has the best balance with transmission of single polarizer and extinction ratio in visible light range.

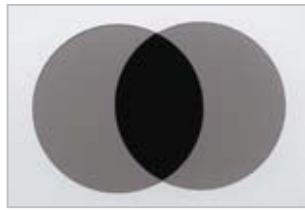

Optical character	Average Transmittance (400~680nm)	Extinction ratio (460nm)	Extinction ratio (530nm)	Extinction ratio (630nm)
POLAX-32N	32%±2%	10 <sup>2</sup>	10 <sup>3</sup>	10 <sup>3</sup>

## POLAX-38N

Visible light range

POLAX-38N is an excellent color reproduction polarizer as transmitting light uniformly in visible light range.

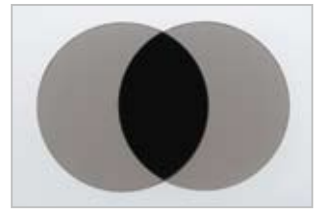

Optical character	Average Transmittance (400~680nm)	Extinction ratio (460nm)	Extinction ratio (530nm)	Extinction ratio (630nm)
POLAX-38N	38%±2%	10	10 <sup>2</sup>	10 <sup>3</sup>

## POLAX-38S

Visible light range

POLAX-38S meets request of higher transmittance and higher extinction ratio in visible light range.

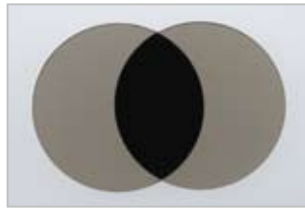

Optical character	Average Transmittance (λ=530nm)	Extinction ratio (460nm)	Extinction ratio (530nm)	Extinction ratio (630nm)
POLAX-38S	38%±3%	10 <sup>3</sup>	10 <sup>4</sup>	10 <sup>4</sup>

## POLAX-42S

Visible light range

POLAX-42S is over 40% transmittance and higher extinction ratio polarizer in visible light range.

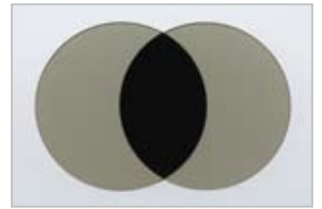

Optical character	Average Transmittance (λ=530nm)	Extinction ratio (460nm)	Extinction ratio (530nm)	Extinction ratio (630nm)
POLAX-42S	42%±3%	10 <sup>2</sup>	10 <sup>4</sup>	10 <sup>4</sup>

## POLAX-32NIR

Near infrared range

POLAX-32NIR is developed for 780nm ~ 830nm in near infrared range.



Optical character	Average Transmittance (λ=780nm)	Extinction ratio (λ=780nm)
POLAX-32NIR	32%±3%	10 <sup>4</sup>

## POLAX-30IR

Near infrared range

POLAX-30IR is for infrared range with 900nm ~ 1600nm, it has uniform spectral characteristic.



Optical character	Average Transmittance (900~1600nm)	Extinction ratio (1060nm)	Extinction ratio (1300nm)	Extinction ratio (1550nm)
POLAX-30IR	30%±3%	10 <sup>3</sup>	10 <sup>4</sup>	10 <sup>3</sup>

## Customized products

LUCEO realizes customer's requests with considering material, shape, size, thickness and so on besides our standard products.

LUCEO's advantage is utilizing resin film, therefore over 30mm diameter products are fabricated.

Even in case of changing wavelength range and transmittance, LUCEO offers products by designing it optically.

# Wave plate

## RETAX Series

RETAX is a wave plate which can make it possible to get specific retardance.

A birefringent film is glued within optical glass plates. LUCEO's line-up includes for specific wavelength and for broadband wavelength range .

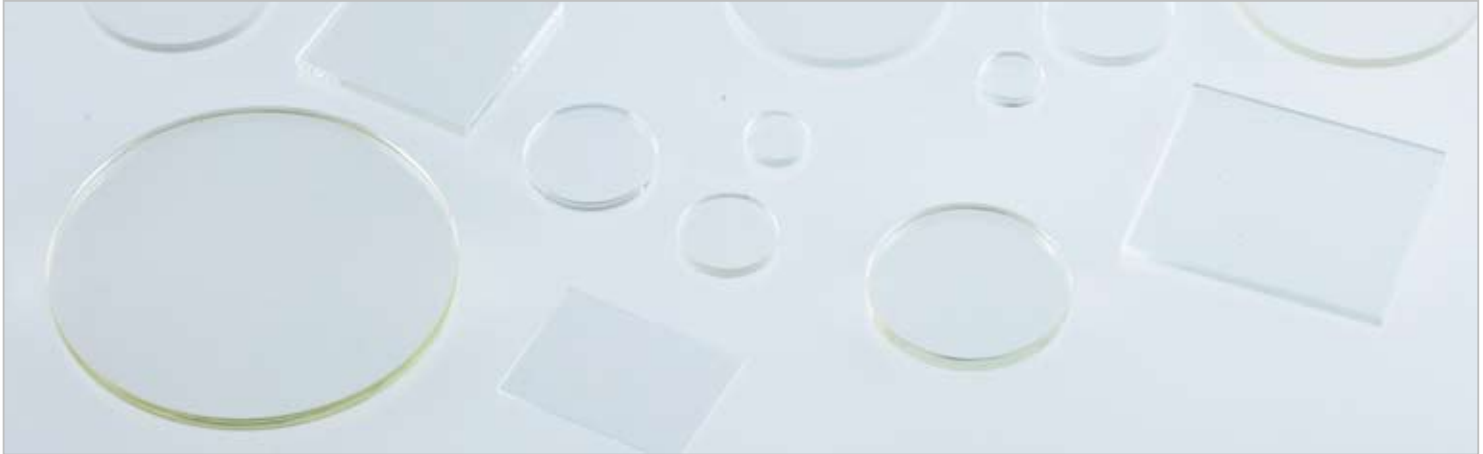

## Function of wave plate

### 1/4-wave plate

1/4 wave plate realizes a quarter retardance to incident light. A circularly polarizing plate is realized when 1/4 wave plate is combined with a linear polarizer. A circularly polarizing plate has a function of isolator to block reflection light from a reflection plane, in case incident light goes into the circularly polarizing plate and the outgoing light is reflected on the reflection plane and goes back into the circularly polarizing plate.

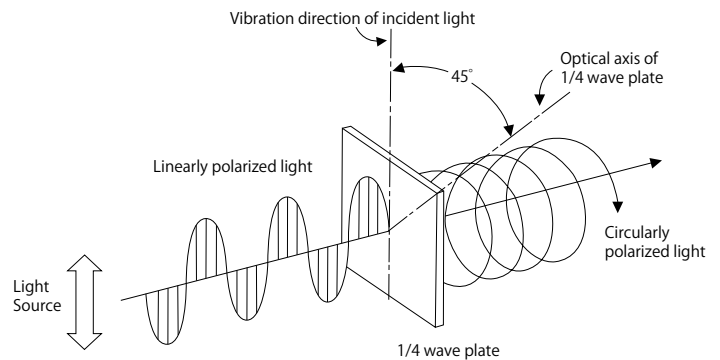

### 1/2-wave plate

1/2 wave plate realizes a half retardance to incident light. When linearly polarized light goes into 1/2 wave plate at an angle of  $\theta$ -degree to an optical axis of the half wave plate, a vibration direction of outgoing polarized light is rotated by  $2\theta$ . Therefore when linearly polarized light goes into a half wave plate at an angle of 45-degree to an optical axis, an outgoing light become a linearly polarized light of which a vibration direction rotated by 90-degree to the initial vibration direction of incident light. When a circularly polarized light goes into a half wave plate, an outgoing light become reverse rotated circularly polarized light.

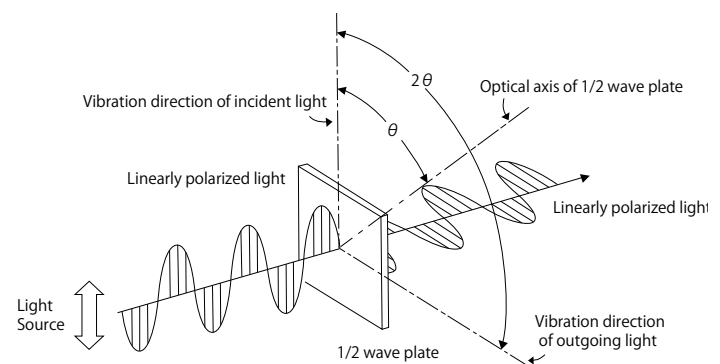

### 1-Lambda wave plate

1-lambda wave plate of RETAX & HI-RETAX is called a sensitive color plate, its specific wavelength is 530nm.

When 1-lambda wave plate is set between 2 pcs of polarizers crossed each other, white light which passes the polarizers and 1-lambda wave plate, is changed to bluish purple light.

This system is called a sensitive color method by utilizing sensitive hue change. This method makes it easier to observe a color change, when a sample with a little birefringence is observed.

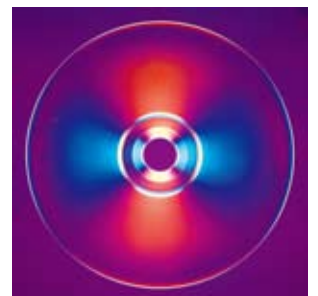

## Wave plate for Specific wavelength

When a linearly polarized light at a specific wavelength goes into these wave plates, the polarized light is converted into a designated retardance.

LUCEO has a various wave plates for each specific wavelength of incident light.

# RETAX

RETAX is one of wave plates consist of better processable birefringent resin film glued within optical glass plates.

**[Range of Retardation]** 30nm ~ 550nm

**RETAX-1/4 λ**

**RETAX-1/2 λ**

**RETAX-1 λ (Sensitive color plate)**

**RETAX-others**



# HI-RETAX

HI-RETAX is one of wave plates consist of thermostable birefringent resin film within optical glass plates.

Even under high temperature condition (approx. 70°C), HI-RETAX has less retardation change, better orientation and stable retardation in-plane.

A similar hue as a crystal and mica wave plate is realized under polarizing observation with HI-RETAX-1 λ -plate.

**[Range of Retardation]** 10nm ~ 550nm

**HI-RETAX-1/4 λ**

**HI-RETAX-1/2 λ**

**HI-RETAX-1 λ (Sensitive color plate)**

**HI-RETAX-others**



## Broad band wave plate in visible light range

Quarter retardance is realized for visible light of any wavelength when linearly polarized light passes through this wave plate B-RETAX.

# B-RETAX-1/4 λ

B-RETAX is wave plate with resin film which realizes 1/4 retardance of any wavelength for visible light range with 1 pc.

**[Retardance]**  $\lambda/4 \pm 13\text{nm}$  ( $\lambda=450\text{nm}, 500\text{nm}, 550\text{nm}, 590\text{nm}, 630\text{nm}$ )



## RETAX • HI-RETAX • B-RETAX Specification of standard products

Glass material	BK7
Size (Diameter)	Φ10 (0/-0.2) mm
	Φ20 (0/-0.2) mm
	Φ30 (0/-0.2) mm
Thickness	2 (±0.2) mm
AR Coating	RETAX•HI-RETAX : None
	B-RETAX: Multi layer coating on both faces

※AR coating is an option.

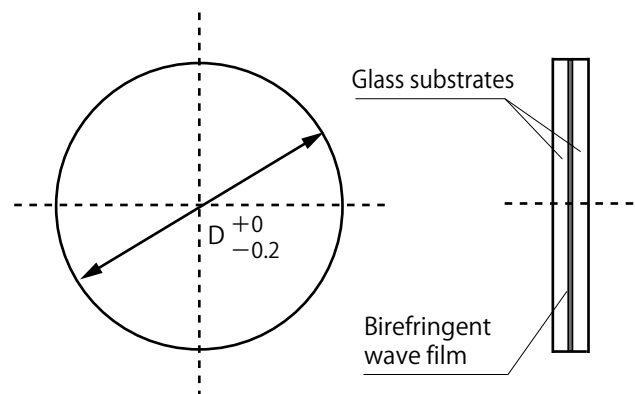

※In case of HI-RETAX, a side is sealed.

## Customized products

LUCEO realizes customer's requests with considering material, shape, size, thickness and so on besides our standard products.

LUCEO's advantage is utilizing resin film, therefore over 30mm diameter products are fabricated. Even in case of changing wavelength range, LUCEO offers products by designing it optically.

# Super Broadband Wave plate

When a linearly polarized light in a specific wavelength range goes into this wave plate, the polarized light is converted into a designated retardance.

## SB-RETAX Super Broadband-RETAX

SB-RETAX is a wave plate realizes constant linear retardance in super broadband of wavelength, when linearly polarized light passes through this wave plate. The wavelength range depends on the number of layers, there are 2 types, 3-layer and 5-layer.



Wavelength range	Type	
450nm ~ 1100nm	<b>SB-RETAX-5L-1/4λ</b>	<b>SB-RETAX-5L-1/2λ</b>
450nm ~ 700nm 500nm ~ 800nm 600nm ~ 900nm 800nm ~ 1100nm	<b>SB-RETAX-3L-1/4λ</b>	<b>SB-RETAX-3L-1/2λ</b>

Glass material	BK7	
Size (Diameter)	Φ20 (0/-0.2) mm	
	Φ25 (0/-0.2) mm	
	Φ30 (0/-0.2) mm	
Thickness	5L	3.0 (±0.3) mm
	3L	2.5 (±0.3) mm
AR Coating	5L	None
	3L	Multi layer coating on both faces

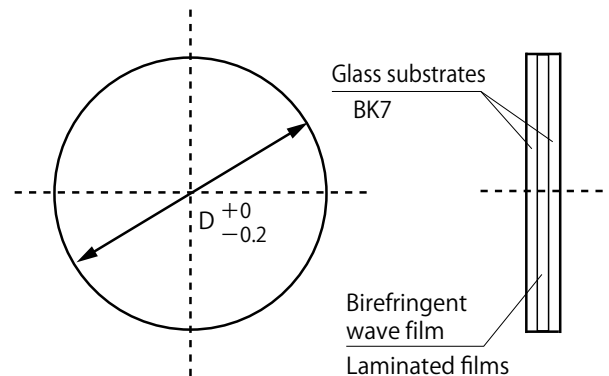

# Circularly polarizing plate

A circularly polarizing plate is fabricated by combining with POLAX and RETAX.

A polarizing film and a birefringent film are glued within glass plates such as optical glass and crystal which have better optical specification.

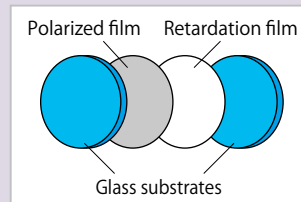

Luceo is the pioneer company that manufactures polarizing plates and wave plates which sandwich optical films manufactured in-house between optical glass plates.

We have been manufacturing various products based on polarization technology with corresponding to the change of times since we founded 50 years ago.



StrainEye LSM-4410LE



StrainEye LSM-7000LE



StrainEye LSM-9000LE



StrainEye LSM-9000S



Striae catcher



Optical unit



Optical lens



Optical prism